

# FMP40

## User Manual



[www.audac.eu](http://www.audac.eu)

#### **ADDITIONAL INFORMATION**

This manual is put together with much care, and is as complete as could be on the publication date. However, updates on the specifications, functionality or software may have occurred since publication. To obtain the latest version of both manual and software, please visit the Audac website @ [www.audac.eu](http://www.audac.eu).

# Index

<b>Introduction</b>	<b>5</b>
<b>Precautions</b>	<b>6</b>
Safety requirements	6
Caution servicing	7
EC Declaration of Conformity	7
Waste of Electrical and Electronic Equipment (WEEE)	7
<b>Chapter 1: Connections and connectors</b>	<b>8</b>
Connection standards	8
<b>Chapter 2: Overview FMP40</b>	<b>9</b>
<b>Chapter 3: Using the FMP40</b>	<b>11</b>
Module screen	11
Settings screen	12
<b>Chapter 4: Installing the FMP40</b>	<b>17</b>
<b>Chapter 5: Additional information</b>	<b>19</b>
Technical specifications	19
Notes	20



# Introduction

## SourceCon™ voice file media player module

The FMP40 is a professional voice file media player featuring SourceCon™ modular technology. This unique technology guarantees true plug & play implementation to any compatible device. When inserted to a supporting slot, the module is instantly installed, discovered and ready for operation without requiring any additional internal wiring or complex configuration.

The FMP40 features 15 contact inputs which can be used for triggering music / voice file messages stored on various types of media carriers. Media playback from USB storage drives is possible when inserted to the controlling device, while an internal Micro SD card slot safely locks the carrier inside for applications where frequent media changes are not required. Media playback is supported in MP3, WMA, WAV, FLAC, OGG and AAC filetypes with numerous supported bitrates.

Each contact is individually configurable, offering selection for the triggered media file and normal open (NO) or normal closed (NC) contact operation. The playback mode can be selected between pulse trigger (play complete track) or stop on release. Event triggering allows triggering at pre-defined moments. Other settings such as priority level assignment and repeat are making the FMP40 a complete and versatile solution for any application requiring voice file playback, ranging from advertisements and announcements to emergency calls.

All contact inputs are implemented using multipin terminal block connectors, while the balanced stereo line output is implemented using two 3-pin terminal block connections.

# Precautions

## READ FOLLOWING INSTRUCTIONS FOR YOUR OWN SAFETY

- ALWAYS KEEP THESE INSTRUCTIONS FOR FUTURE REFERENCE. NEVER THROW THEM AWAY
- ALWAYS HANDLE THIS UNIT WITH CARE
- HEED ALL WARNINGS AND FOLLOW ALL INSTRUCTIONS
- AVOID ELECTROSTATIC DISCHARGE BY TOUCHING GROUNDED POINT BEFORE REMOVING THE MODULES FROM THEIR PROTECTIVE BAG
- AVOID TOUCHING OF THE COMPONENTS ON THE CIRCUIT BOARD DIRECTLY
- NEVER EXPOSE THIS EQUIPMENT TO RAIN, MOISTURE, ANY DRIPPING OR SPLASHING LIQUID. NEVER PLACE AN OBJECT FILLED WITH LIQUID ON TOP OF THIS DEVICE
- DO NOT INSTALL THIS UNIT NEAR ANY HEAT SOURCES SUCH AS RADIATORS OR OTHER APPARATUS THAT PRODUCE HEAT
- DO NOT PLACE THIS UNIT IN ENVIRONMENTS WITH A HIGH LEVEL OF DUST, HEAT, MOISTURE OR VIBRATION
- THIS UNIT IS DEVELOPED FOR INDOOR USE ONLY. DO NOT USE IT OUTDOORS
- ONLY USE ATTACHMENTS & ACCESSORIES SPECIFIED BY THE MANUFACTURER.
- UNPLUG THIS APPARATUS DURING LIGHTNING STORMS OR WHEN UNUSED FOR LONG PERIODS OF TIME
- CAREFULLY CHECK THE UNIT'S CONDITION AFTER UNPACKING. IF THERE IS ANY DAMAGE TO THE CARTON BOX OR THE UNIT ITSELF, INFORM YOUR VENDOR IMMEDIATELY.
- ONLY CONNECT THIS UNIT TO A MAINS SOCKET OUTLET WITH PROTECTIVE EARTHING CONNECTION
- THE INSTALLATION, CONNECTION AND CONFIGURATION OF THE DEVICE SHOULD BE DONE BY QUALIFIED TECHNICIANS



### CAUTION – SERVICING

This product contains no user serviceable parts. Refer all servicing to qualified service personnel. Do not perform any servicing (unless you are qualified to do so.)



### EC DECLARATION OF CONFORMITY

This product conforms to all the essential requirements and further relevant specifications described in following directives: 2014/30/EU (EMC) and 2014/35/EU (LVD)



### WASTE ELECTRICAL AND ELECTRONIC EQUIPMENT (WEEE)

The WEEE marking indicates that this product should not be disposed with regular household waste at the end of its product life. This regulation is created to protect both the environment and human health.

This product is developed and manufactured with high quality materials and components which can be recycled and/or reused. Please dispose of this product at your local collection point or recycling centre for electrical and electronic waste. Do this to make sure that the product is recycled in an environmental friendly way, and help to protect the environment in which we all live.

### CAUTION

The symbols shown are internationally recognized symbols that warn about potential hazards of electrical products. The lightning flash with arrowpoint in an equilateral triangle means that the unit contains dangerous voltages. The exclamation point in an equilateral triangle indicates that it is necessary for the user to refer to the users manual.



These symbols warn that there are no user serviceable parts inside the unit. Do not open the unit. Do not attempt to service the unit yourself. Refer all servicing to qualified personnel. Opening the chassis for any reason will void the manufacturer's warranty. Do not get the unit wet. If liquid is spilled on the unit, shut it off immediately and take it to a dealer for service. Disconnect the unit during storms to prevent damage.

# Chapter 1

## Connections and connectors

### CONNECTION STANDARDS

The in- and output connections for AUDAC audio equipment are performed corresponding to international wiring standards for professional audio equipment.

#### 3-Pin terminal block:

For balanced in & output connections

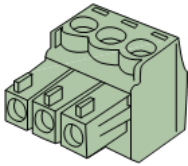

**Left:** Signal – (XLR Pin 3)  
**Center:** Signal + (XLR Pin 2)  
**Right:** Ground (XLR Pin 1)

For balanced line output connections:

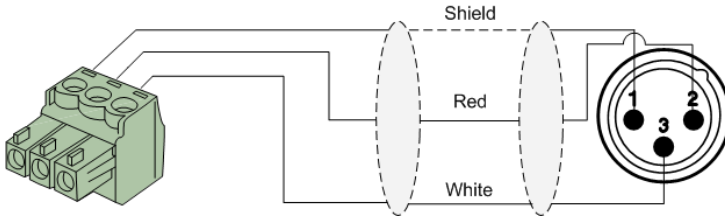

For unbalanced line output connections:

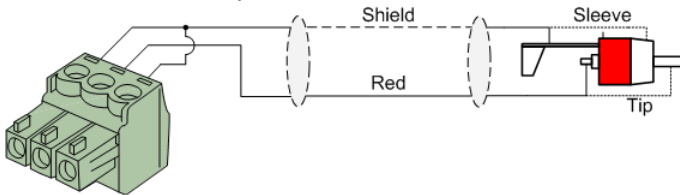



# Chapter 2

## Overview FMP40

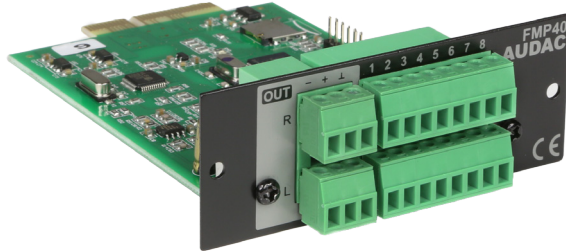

The FMP40 is a SourceCon™ compatible module featuring an (internal) board–edge connector which carries all signals for getting it connected to any supporting main unit.

All external in & output connections shall be made using the available connectors on the panel.

### 1) Balanced stereo line output:

The balanced stereo line output is implemented using two 3–pin terminal block connectors. The audio output available on this connector allows it to be fed to any amplifier or pre–amplifier.

### 2) Trigger contact inputs:

The 15 contact inputs are implemented through dual–row 8–pin terminal block connectors. All of them are (software) configurable as NO (normal–open) or NC (normal–closed) contacts allowing connection for any type of external trigger (switch, relay, ... ).

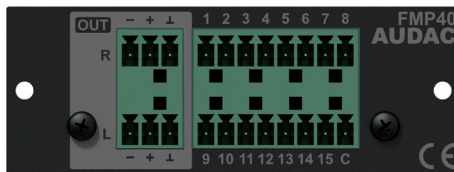

The contacts pinout is indicated in the above image, with in the bottom right corner the 'C' (common) terminal.

A connection between all contact inputs (1 to 15) and the 'C' (common) terminals shall always be made, as indicated in the below diagram.

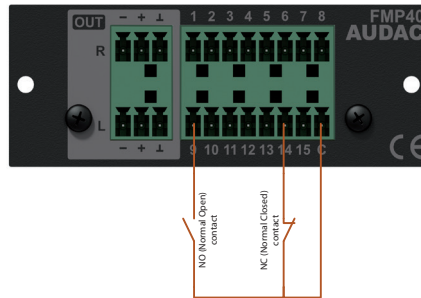

Depending of the application, a selection of NO (normal–open) or NC (normal closed) contacts can be made through software configuration. NO contacts can be triggered by standard tact switches, while NC contacts offer the additional advantage that a wire interruption is detected as a contact trigger (which often is a requirement for alarm or emergency announcement systems).

### 3) Micro SD card slot:

The micro SD card slot (with pre–installed micro SD card) allows integrated installation of the media carrier. When no frequent changes of announcements / alarms are required (e.g. alarm & announcement systems) it is recommended for having the media carrier internally installed avoiding removal by unauthorized users.

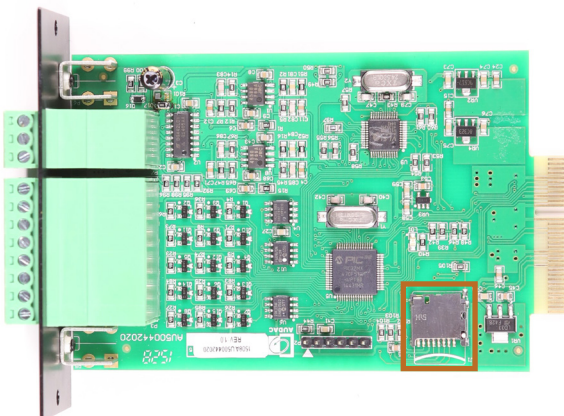

Micro SD card slot (indicated in orange square) on FMP40

# Chapter 3

## Using the FMP40

Since the FMP40 is a SourceCon™ module, it can be combined with a variation of supporting main units. The operation and configuration interface might be different of the unit where installed, however the offered functionality is identical. Some devices will support control and configuration through a front panel graphical control interface on a display, while others are also supporting web-control.

This manual describes the control configuration possibilities using front panel control. For applications where more control possibilities are offered, check the instruction manual of the used main device for more instructions.

## Module screen

The module screen gives an overview of the FMP40's current operation mode. If any voice file is triggered (track is playing), the currently playing track name and progress will be indicated on this screen.

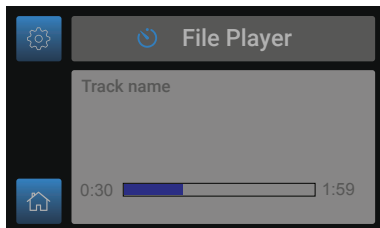

### Settings:

The ⚙️ (settings) button gets you to the settings menu of the FMP40 where all configurations can be made.

### Home:

The 🏠 (home) button gets you back to the main screen of the device where the FMP40 is installed to.

# Settings screen

The settings screen allows configuration for all FMP40 settings.

## Contacts:

The contacts menu gives an overview of all 15 contact inputs, allowing them to be switched between Normal Open (NO) and Normal closed (NC) configuration.

Switching between contacts is done by rotating the function dial, while toggling between Normal Open and Normal Closed is done by pressing the function dial. To return back to the main settings menu, select 'BACK' in the bottom right corner.

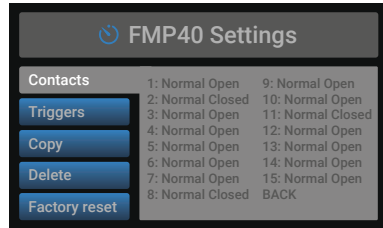

## Triggers:

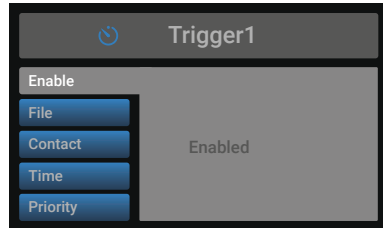

The triggers menu gives an overview of all the triggers controlling voice files to play. A maximum of 50 triggers can be configured by a contact closure or a timed (pre-programmed) event. When selecting the 'Triggers' option, a screen allowing selection between all 50 triggers will be shown. Select the corresponding trigger to proceed to the corresponding trigger settings.



## Trigger > Enable:

The 'Enable' option allows to enable or disable the selected trigger number. Press the rotary dial for toggling between Enabled and Disabled.

## Trigger > File:

The 'File' option allows selection of the voice file which starts playing when triggered. Using the  (USB) and  (SD-card) knobs, switching between both media carriers is done. When the media carrier is selected, an overview of the stored (supported) media files is listed. Browsing between the media files is done by turning the function dial, while the currently highlighted file can be pre-listened though pressing the  button. For selecting the currently highlighted media file, press the function dial for confirmation. A single file (track) or a complete folder can be selected. When selected a folder, all contained files will play subsequently (when selected the corresponding playmode)

### Trigger > Contact:

The 'Contact' option offers the possibility for assigning a contact input enabling the selected trigger. A selection out of the 15 available contact inputs can be made. Browsing between various contact inputs is done by turning the function dial, while selection is done by pressing it for confirmation.

### Trigger > Time:

The 'Time' option offers the possibility for assigning a pre-programmed (timed) event to the selected trigger. This menu contains various sub-divisions for Months, Days, Time, Start and Stop.

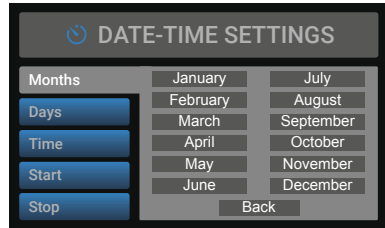

The selected trigger will be enabled whenever all entered parameters are true.

When more parameters are entered, each entered parameter is an additional condition which will require all conditions being true before enabling the trigger.

#### NOTE

When using the timer triggering for announcements, make sure the playmode is configured as 'Repeat number of times' (See chapter 'Trigger > Playmode')

– **Month:** Offers selection criteria for pre-programmed triggers being effective in certain months only. All months are default configured as enabled (but can be disabled), meaning the corresponding trigger will be effective for all months. Browsing through months is done by turning the function dial, while selections are confirmed by pressing it. Select 'Back' to get up in the menu structure.

– **Days:** Offers selection criteria for pre-programmed triggers being effective on certain days only. Possibilities are given for selection on 'Days of Month' (1 to 31) or 'Days of Week' (Monday till Sunday). If both criteria are entered ('Days of Month' & 'Days of week'), the corresponding trigger will only be effective when both are true. Browse through days by turning the function dial, while selections are confirmed by pressing the function dial. Select 'Back' to get up in the menu structure.

– **Time:** Offers selection criteria for the exact time (Hours & Minutes) when the pre-programmed trigger shall be effective.

– **Start / Stop:** Gives the possibility for entering a specific start and/or stop date for the time trigger. When enabled, the selected trigger will only be effective if the current date is between the configured start and stop date. Toggling between enabled, disabled and the actual date configuration (if enabled) is done by turning the function dial, while pressing confirms and proceeds to the next step.

- **Clear:** Clears all the currently made settings for the selected trigger's time settings.

#### NOTE

For time keeping, the main unit where to installed the FMP40 shall get synchronization from a time server. When internet access is available, an internet timeserver will guarantee accurate synchronization of the system according to GMT. In case your system is restricted from access to internet, an internal time server on your LAN network should get assigned offering synchronization to the system.

#### Trigger > Priority:

The 'Priority' option allows assignment of a priority levels for the selected trigger. The priority level can be selected within a range of 1 to 50, having the lowest (1) number the highest level of priority. When multiple triggers are simultaneous effective, the trigger with highest priority (lowest number) will interrupt the others. When two triggers with identical priority are effective, the first activated one will remain active. Browsing between priority levels is done by turning the function dial, while pressing it confirms the current selection.

#### Trigger > Playmode:

The 'Playmode' option offers various playmode selection possibilities for the currently selected trigger, which are selectable between:

- **Repeat file while trigger active:** Infinitely repeats the configured file while trigger is active (contact activated) and instantly stops playing once released. (contact triggering)

- **Repeat folder while trigger active:** Sequentially plays all tracks in the selected folder (if a folder is selected) while trigger is active (contact activated) and instantly stops playing once released. Once released and re-triggered, playback will start again from the beginning of the first track. (contact triggering)

- **Repeat number of times:** Repeats the configured file for the selected number of times when momentary triggered. (timer and contact triggering)

- **Repeat number of times while trigger active:** Repeats the configured file for the selected number of times while trigger is active (contact activated) and instantly stops playing once released. (contact triggering)

- **Repeat all while trigger active:** Sequentially plays all tracks on the selected media drive while trigger is active (contact activated) and instantly stops playing once released. The first track to be played shall be configured and once released and re-triggered, playback will start again from this track. (contact triggering)

### Trigger > Gain:

The gain (output level) for each trigger can be adjusted within a range of +8 dB and -92 dB, allowing various situations with different output levels (e.g. an emergency alarm with higher volume than general announcements). The level can be adjusted by rotating the function dial clockwise (tuning up) or counter-clockwise (tuning down). Press it for confirming the current selection.

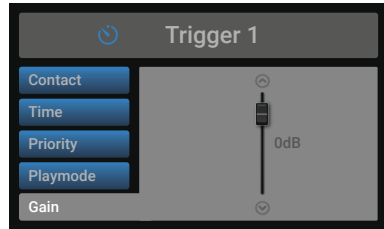

### Trigger > Name:

Custom naming allows keeping a clear overview of all configured triggers. Naming with a maximum of 10 characters can be given to each trigger. Character browsing is done by turning the function dial while the current selection (highlighted) is confirmed by pressing. Default or configured naming can be removed by selecting the 'Delete' option, while 'Save' confirms the current naming and gets you back to the trigger menu.

### Trigger > Delete:

Delete removes all the currently made trigger settings, and sets everything (for this trigger only) back to factory defaults.

### Copy:

The copy menu allows copying of media files from the USB media carrier (inserted to the front panel of the supported main unit) to the internal media carrier (Micro SD card) of the FMP40. When no frequent changes of announcements / alarms are required (e.g. alarm & announcement systems) it is recommended to have the files stored on the internal media carrier, avoiding failures due to removal by unauthorized users.

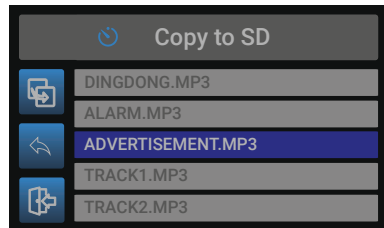

An overview of all available folders and files on the inserted USB drive is given. Browsing through the media files is done by turning the function dial, while the currently highlighted file can be copied by pressing the  (copy) button.

**Delete:**

The delete menu allows removal of media files stored on the internal media carrier (Micro SD card). An overview of the stored media files (on Micro SD card) is listed. Browsing through the media files is done by turning the function dial, while the currently highlighted file can be removed by pressing the  (delete) button. Note that deleted files are permanently removed and cannot be recalled afterwards.

**Factory reset:**

Factory reset will recall all settings to factory defaults and all previously made settings and configurations will be lost. After selecting factory reset, a confirmation will be asked whether all settings definitely need to be reset to factory defaults. When confirmed, all settings will be lost.

**Back:**

Returning to the module screen is done by selecting 'Back'.



# Chapter 4

## Installing the FMP40

### CAUTION



Before installing the FMP40 to any SourceCon™ compatible device, make sure the power is switched off. Malfunctions or electrical shocks may occur otherwise.

### Step 1:

Make sure that the slot whereto the module should be installed is open and ready for installation. Depending of the main unit, some module slots will be covered by blind panels when delivered. The corresponding blind panels should be removed by releasing the screws on both ends.

### Step 2:

Before removing the modules from their protective bag, we recommend touching a grounded metal chassis (or any other grounded point) to prevent electrostatic discharges affecting the sensitive electronic components. It is recommended to always hold the module card by the metal connection panel and avoid touching of the components on the circuit board directly.

### Step 3:

Align both edges of the module with the guide rails inside the slot and carefully insert the module into the slot. It should slide into the slot without any considerable resistance when well positioned into the guide rail.

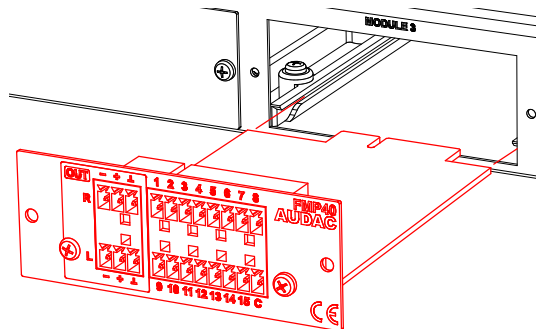

**Step 4:**

Some resistance might occur when the module's board edge connector reaches the connection counterpart on the main board. Gently push the module all the way into the slot to ensure that the contacts are correctly inserted. The module is well inserted when its connection panel touches the metal chassis of the main device where inserted to.

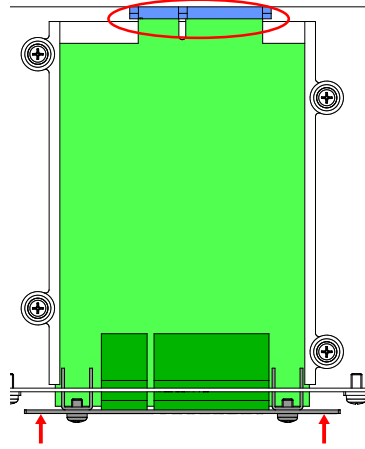

**Step 5:**

Fasten the module into the slot using the included screws. Be aware that damage or malfunctions may occur if the module is not correctly fastened.

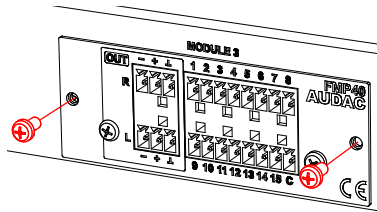

**Step 6:**

Once the module correctly installed, the system can be powered-on and the module functionality will be automatically discovered.

# Chapter 5

## Technical specifications

Connection	SourceCon™ interface card slot
Input	15 trigger contact inputs (NO or NC) (2 x 8-pin Euro Terminal Block ~ 3.81 mm)
Output	Balanced stereo line output (2 x 3-pin Euro Terminal Block ~ 3.81 mm)
Output level	+8 dB ~ -91 dB (Software configurable)
Compatible media playback	USB Flash drive / HDD (external) Micro SD card (internal)
Compatible filesystems	FAT16/FAT32
Supported filetypes playback	MP3 V1.0, V2.0, V2.5 Ogg vorbis MPEG4/2 AAC-LC+PNS HE-AAC v2 (Level 3), SBR+PS WMA 4.0/4.1/7/8/9 WAV (PCM + IMA ADPCM); General MIDI 1 / SP-MIDI
Signal/noise	94 dB
THD+N	< 0.03%
Frequency response	20 Hz – 20 kHz
Crosstalk	80 dB
Power consumption	1.0 Watt
Dimensions (W x H x D)	87 x 34.5 x 114 mm
Weight	0.079 Kg
Packaging	Carton box
Shipping weight & Volume	1.08 Kg – 0.028 Cbm
Compatible devices	XMP44 Modular audio system
Accessories included	Micro SD memory card (128 MB)

# Notes

---

---

---

---

---

---

---

---

---

---

---

---

---

---

---

---

---

---

---

---

---

---

---

---

---

---

---

---